

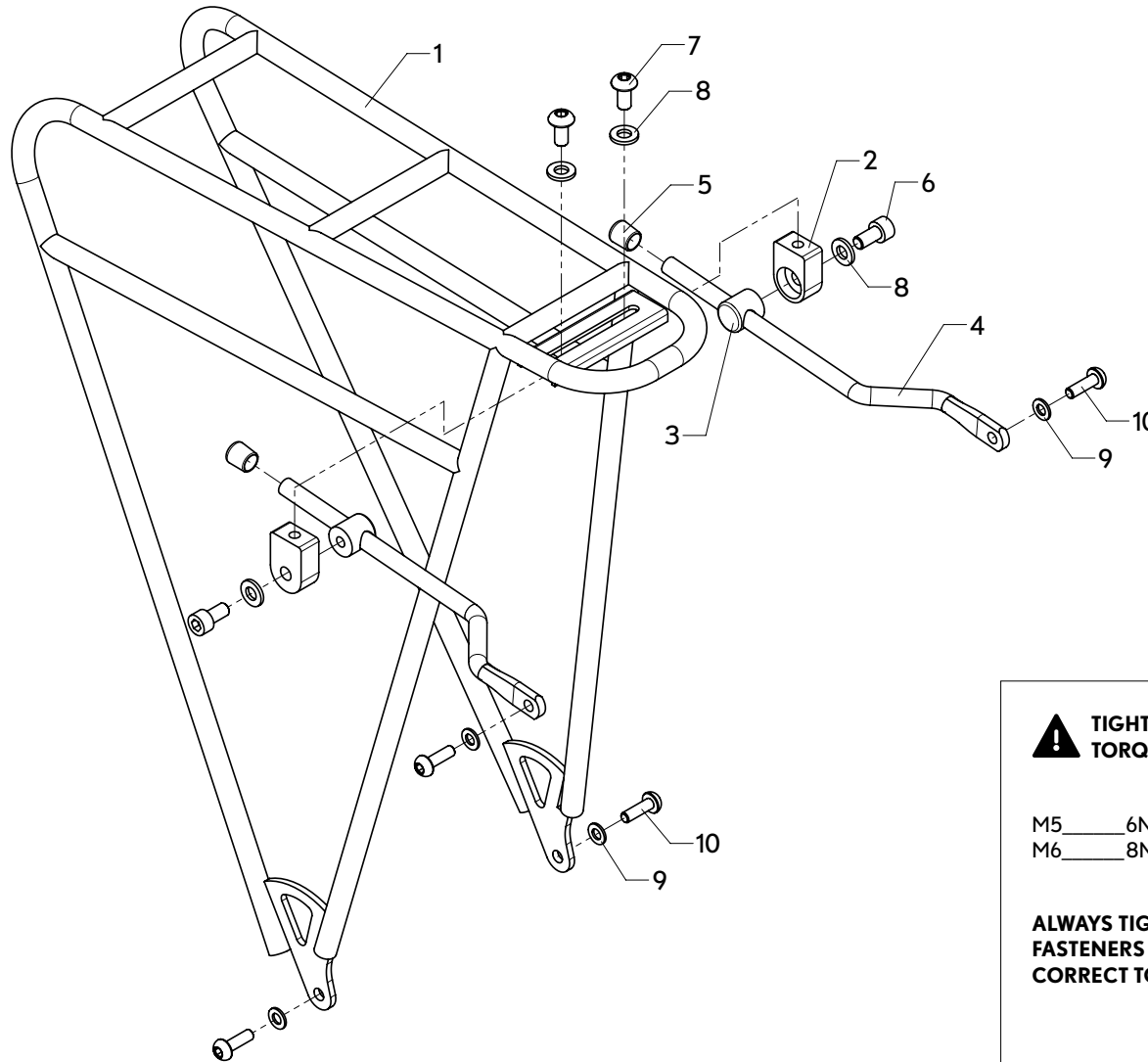

# COMMUTER REAR RACK 2017 ASSEMBLY INSTRUCTIONS

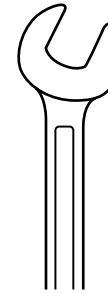

## REQUIRED TOOLS (NOT INCLUDED IN THE SALES PACKAGE)



8MM NUT SPANNER

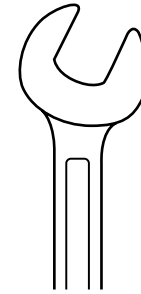

10MM NUT SPANNER

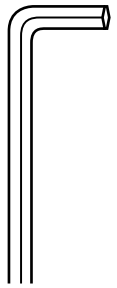

4MM HEX WRENCH

## PARTS LIST

Part no.	Part name	Q'ty
1	Rack	1
2	Adjustable mounting part 1	2
3	Adjustable mounting part 2	2
4	Adjustable mounting stay	2
5	Plastic cap	2
6	M6 screw	2
7	M6 screw	2
8	M6 washer (integrated with the bolt 6 and 7)	4
9	M5 Washer	4
10	M5x16 Screw	4

## TIGHTENING TORQUES

M5 \_\_\_\_\_ 6NM  
M6 \_\_\_\_\_ 8NM

**ALWAYS TIGHTEN  
FASTENERS TO THE  
CORRECT TORQUE**

## SCREW SET (1:1)

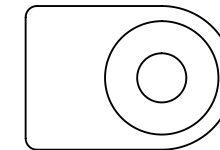

#2

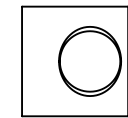

#3

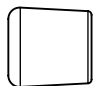

#5

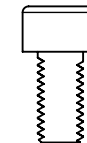

#6

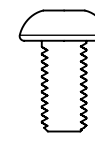

#7



#8



#9

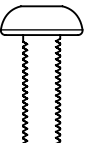

#10

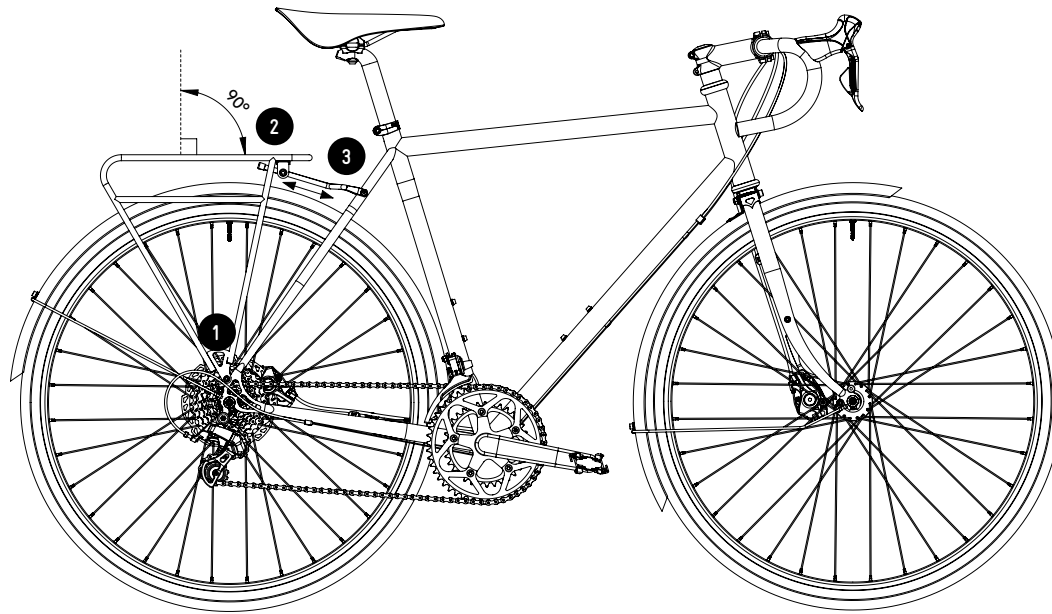

## PRODUCT INFO

### ⚠ PLEASE TAKE NOTE BEFORE ASSEMBLING THE RACK TO YOUR BICYCLE

1. Make sure your bicycle has the necessary mounting spots to mount the carrier
2. The product is designed to fit regular bicycles with 26-28" wheels
3. Make sure that your bicycle is strong and stable enough to carry a rear load
4. This carrier is not designed to carry any people or animals
5. The package includes small parts - Keep away from children under 3yrs
6. Follow the assembly instructions carefully
7. In any assembly problem turn to a professional bicycle mechanic
8. Any kind of structural changes made to the carrier are strictly forbidden
9. Improper assembly can lead to product failure

### ⚠ PLEASE TAKE NOTE WHEN RACK IS IN REGULAR USE

1. Make sure you don't exceed the total load of your bicycle or carrier
2. Check the tension of all mounting screws and bicycle attachment points regularly
3. Tighten all bolts to their stated Nm torques. A precise tightening torque will be achieved with a torque wrench
4. Do not attach a child seat to the carrier. The carrier is not approved to carry children, adults or animals
5. Do not attach any pressure- or clamp-style attachments to any parts of the carrier
6. Any type of physical or technical alterations to the carrier are strictly forbidden
7. Make sure there are no loose straps or cords that could be caught in the back wheel while in motion
8. Make sure that luggage weight is distributed as evenly as possible
9. Make sure that all required reflectors and lights are visible and not covered by carrier or luggage
10. Remove all luggage from carrier when transporting a bicycle in any vehicles

### WARRANTY

1. Guarantee of a Pelago product applies only to total product failure or breakage
2. Any other damage resulting from scratches, rust, improper mounting or deformation are excluded from the warranty
3. Only the original owner of the product is entitled to make a guarantee claim

### CARRIER WEIGHT LIMITS

Rack platform 25 kg

**DO NOT EXCEED THE WEIGHT LIMITS**

Liability arising from errors or mistakes is not accepted.  
Pelago reserves the right to any changes without prior notice.

#### 1 Attach rack to rear dropout eyelets.

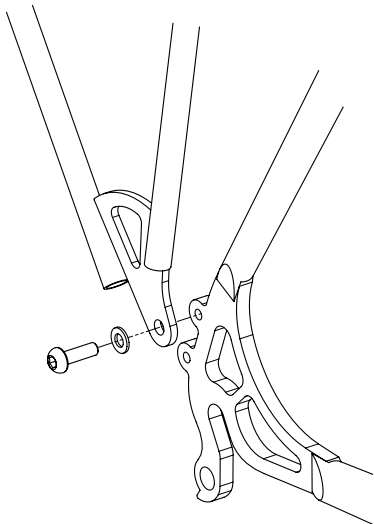

#### 2 Adjust and attach stays to rack seat stay rack mounts.

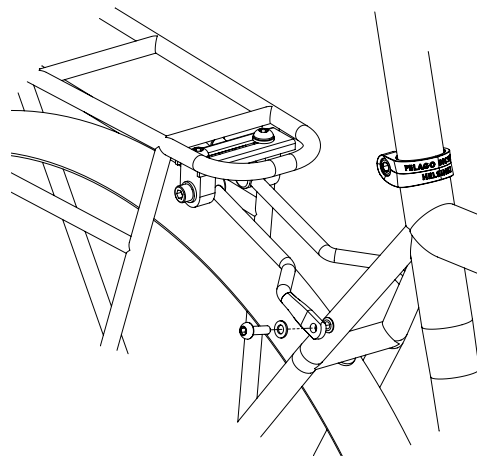

#### 3

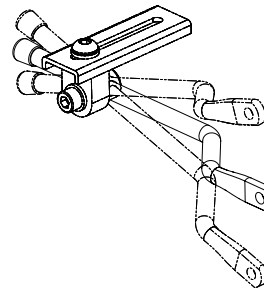

### RACK STAY DO-IT-YOURSELF ADJUSTMENT

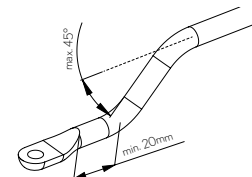

### MANUFACTURER

Pelago Mfg Ltd.  
Helsinki, Finland  
info@pelagobicycles.com  
TEL +358 (0)45 161 6847

**Pelago**  
BICYCLES