



Scan to see features and videos



Download **Lezyne LED Ally** to pair lights & customize modes

English User Manual

READ ENTIRE MANUAL BEFORE OPERATION to ensure proper use and care of your new Lezyne LED light. Traffic laws mandating lighting vary from country to country. Inform yourself about lighting laws and regulations in the country of use. Lezyne LED lights do not conform to the German road traffic regulation StVZO.

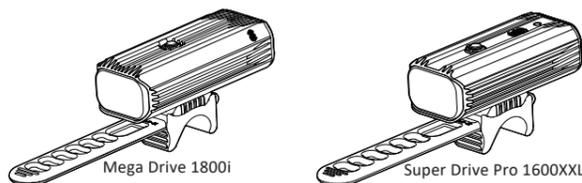

Warnings

DO NOT LOOK DIRECTLY INTO LIGHT BEAM or shine into eyes of another.

Lezyne LED Lights have a water resistance rating of IPX7 under IEC standard 60529. Submerging the device is not recommended. If moisture does enter the casing, air out until completely dry.

DO NOT ATTEMPT TO REMOVE ELECTRONICS. Doing so will void warranty.

Lezyne USA, Inc. does not accept any liability for injuries or other damages resulting from the use of this product in any circumstances.

Warranty

In U.S. and U.K., Lezyne LED Lights carry a two (2) year warranty from the original purchase date to the original owner (proof of purchase required). Lezyne Batteries carry a six (6) month warranty from the original purchase date. Lezyne warranties cover any manufacturing defects in materials or workmanship. Issues not covered by warranty include normal wear & tear, improper installation, attempting to access or modify electronics, damage or failure due to accident, misuse, abuse and/or neglect.

For all warranty issues worldwide, please contact the retailer that sold the product.

For any warranty questions contact: warranty@lezyne.com

Mounting / Montaje

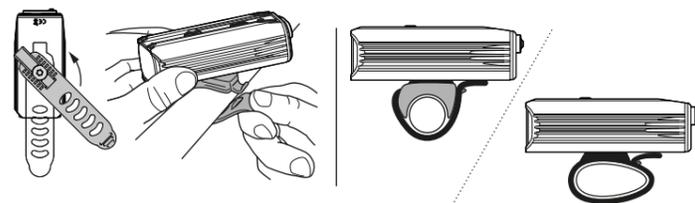

Operation

- On/Off: hold button two (2) sec.
- Mode cycle: click button

RACE MODE: With the light OFF, hold button for five (5) seconds, until light flashes. The light is now in Race Mode where only Overdrive and Economy outputs are selectable. The light will remain in Overdrive Race Mode even when switched OFF. Repeat the step above to return to the normal mode set.

MODE MEMORY: The light remains in the output setting it is switched OFF in.

THERMAL PROTECTION: If the operating temperature of the light is too high, the light automatically lowers the lumen output.

Run Times and Modes

MEGA DRIVE 1800i										
	BLAST	ENDURO	ECONOMY	FEMTO	DAY FLASH	FLASH1	FLASH2	PULSE	OVERDRIVE	
	1000 LUMENS	600 LUMENS	250 LUMENS	15 LUMENS	600 LUMENS	150 LUMENS	150 LUMENS	150 LUMENS	1800 LUMENS	
	2:30 h:min	3:45 h:min	10:00 h:min	148:00 h:min	21:00 h:min	33:00 h:min	36:00 h:min	38:00 h:min	1:40 h:min	

SUPER DRIVE 1600XXL										
	BLAST	ENDURO	ECONOMY	FEMTO	DAY FLASH	FLASH1	FLASH2	PULSE	OVERDRIVE	
	1000 LUMENS	600 LUMENS	250 LUMENS	15 LUMENS	600 LUMENS	150 LUMENS	150 LUMENS	150 LUMENS	1600 LUMENS	
	2:30 h:min	3:45 h:min	10:00 h:min	148:00 h:min	20:10 h:min	33:00 h:min	36:00 h:min	38:00 h:min	1:45 h:min	

Packaging include

	MOUNTING STRAP	USB CABLE	KTV PRO SMART REAR	HANDLE BAR MOUNT	POWER PACK	REMOTE SWITCH
MEGA DRIVE 1800i	●	●				
MEGA DRIVE 1800i LOADED PRO	●	●	●	● (AL)	●	●
SUPER DRIVE 1600XXL	●	●				
SUPER DRIVE 1600XXL LOADED	●	●	●	● (CM)		

Power Pack Operation (Mega Drive 1800i loaded ONLY)

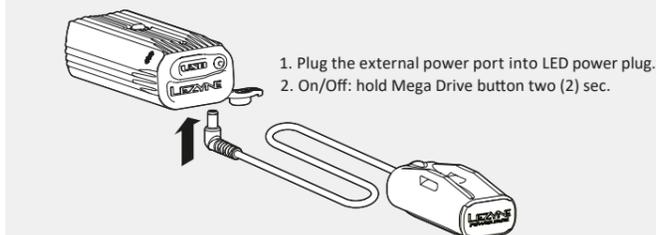

Remote Switch (Mega Drive 1800i loaded ONLY)

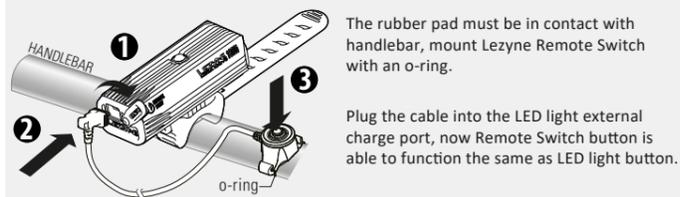

KTV Pro Smart Rear Instruction (Mega / Super loaded ONLY)

BATTERY						MOUNTING
100-75%	75-25%	2-50%				
CHARGING						
						on/off: hold 2 sec
charging	charged					3hr USB charge
RUN TIMES AND MODES						
	BLAST	ECONOMY	DAY FLASH	FLASH1	FLASH2	
	20 LUMENS	3 LUMENS	75 LUMENS	25 LUMENS	10 LUMENS	
	4:00 h:min	18:00 h:min	10:00 h:min	8:45 h:min	19:30 h:min	

Handlebar mount Instruction (Mega / Super loaded ONLY)

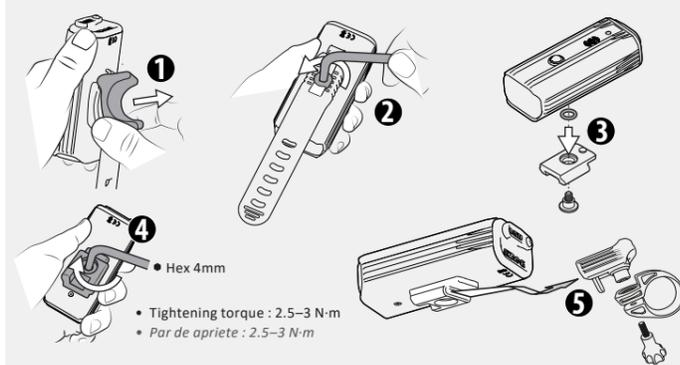

Battery Indicator

An LED, located in the button, displays current battery status while light is ON. When light is OFF, click button once to momentarily display battery status.

100%	50%	10%	5%
Illuminates green	Illuminates yellow	Illuminates red	Flashes red

Charging

Before using your Lezyne LED Light for the first time, fully charge the battery.

To charge your light:

- Switch light OFF
- Remove USB protective cover
- Connect micro USB cable and light to powered USB port
- Once charging, button will flash green; if USB port is capable, light will use High Efficiency (HE) charging and button will flash blue

If button does not flash when plugged in, selected USB port may not be powered—try another USB port.

Light will be charged after 8–9 hours (4–6 with HE charging) or when button illuminates solid green or blue.

- Remove light from charger and reinstall USB protective cover—ensure USB protective cover is fully installed for water resistance

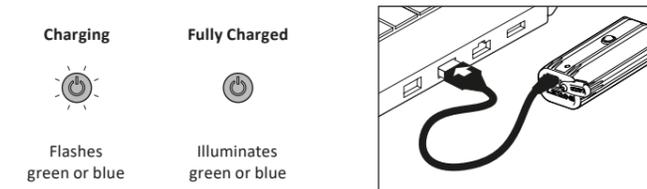

More Information

For more information on Lezyne products, visit: www.lezyne.com

Manual de Uso Español

POR FAVOR, LEA TODO EL MANUAL ANTES DE SU OPERACIÓN para asegurar un buen uso y cuidado de su nueva luz Lezyne LED. Las normas de tránsito que regulan la iluminación varían de un país a otro. Infórmese de las normas del país de uso. Las Luces LED de Lezyne no cumplen con las regulaciones de la circulación alemanas StVZO.

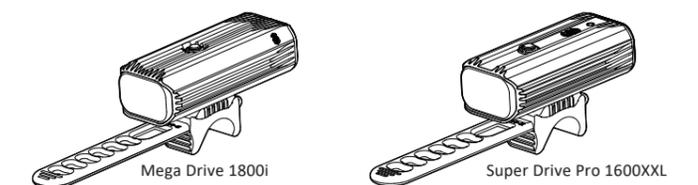

Advertencias

NO MIRE DIRECTAMENTE AL RAYO DE LUZ ni lo apunte a los ojos de otra persona. Las luces LED de Lezyne cuentan con una protección resistente al agua IPX7 que cumple con el estándar IEC 60529. No recomendamos sumergir el dispositivo debajo del agua. En caso que la humedad entre dentro, airee la luz hasta que esté completamente seca.

NO INTENTE RETIRAR LOS COMPONENTES ELECTRÓNICOS. Si lo hace, anulará la garantía.

Lezyne USA, Inc. no asume ninguna responsabilidad por las lesiones u otros daños que resulten del uso de este producto bajo ningunas circunstancias.

Garantía

En los EE. UU. y el Reino Unido, las luces Lezyne LED tienen una garantía de dos (2) años desde la fecha de compra por parte del propietario original (es necesario mostrar el comprobante de compra). Las baterías Lezyne tienen una garantía de seis (6) meses desde la fecha de compra original. Las garantías Lezyne cubren cualquier defecto de fabricación en los materiales o la mano de obra. Estas garantías NO cubren el desgaste normal por el uso, instalación incorrecta, intento de acceso o modificación de los componentes electrónicos, daños o averías debido a un accidente, uso indebido, abuso y/o negligencia.

Para cuestiones de garantía en otros países, contacte directamente con su distribuidor/vendedor.

Si tiene cualquier duda acerca de la garantía póngase en contacto con: warranty@lezyne.com

Funcionamiento

- Encendido/Apagado: presione el botón durante dos (2) segundos.
- Modo de ciclos: presione el botón

MODO "RACE": con la luz apagada (OFF), presione el botón durante cinco (5) segundos hasta que la luz parpadee. La luz está ahora en Modo Race, sólo se podrán seleccionar los modos Overdrive y Economy. La luz se mantendrá en Modo Overdrive Race incluso una vez apagada (OFF). Para cambiar a modo normal, vuelva a presionar el botón durante cinco (5) segundos.

MODO MEMORIA: La luz permanece en el ajuste de salida OFF.

PROTECCIÓN TÉRMICA: si la temperatura en funcionamiento es muy elevada, la luz disminuirá automáticamente la salida de lúmenes.

Tiempos de Uso y Modos

MEGA DRIVE 1800i										
	BLAST	ENDURO	ECONOMY	FEMTO	DAY FLASH	FLASH1	FLASH2	PULSE	OVERDRIVE	
	1000 LUMENS	600 LUMENS	250 LUMENS	15 LUMENS	600 LUMENS	150 LUMENS	150 LUMENS	150 LUMENS	1800 LUMENS	
	2:30 h:min	3:45 h:min	10:00 h:min	148:00 h:min	21:00 h:min	33:00 h:min	36:00 h:min	38:00 h:min	1:40 h:min	

SUPER DRIVE 1600XXL										
	BLAST	ENDURO	ECONOMY	FEMTO	DAY FLASH	FLASH1	FLASH2	PULSE	OVERDRIVE	
	1000 LUMENS	600 LUMENS	250 LUMENS	15 LUMENS	600 LUMENS	150 LUMENS	150 LUMENS	150 LUMENS	1600 LUMENS	
	2:30 h:min	3:45 h:min	10:00 h:min	148:00 h:min	20:10 h:min	33:00 h:min	36:00 h:min	38:00 h:min	1:45 h:min	

Indicador del Estado de la Batería

Luz LED colocada en el botón que muestra el estado actual de la batería mientras la luz está encendida (ON). Cuando la luz esté apagada (OFF), presione el botón una vez para ver momentáneamente el estado de la batería.

100%	50%	10%	5%
Verde iluminado	Amarilla iluminado	Rojo iluminado	Rojo intermitente

Carga

Antes de utilizar la luz LED por primera vez, cargue completamente la batería. Para cargar su luz:

- Apague la luz
- Retire la cobertura protectora de la entrada USB
- Conecte el cable micro USB y la luz a un puerto USB activo.
- Una vez esté cargando, la luz parpadeará de color verde; si el puerto USB lo permite, la luz utilizará carga de Alta Intensidad y el botón parpadeará de color azul.

Si la luz del botón no parpadea una vez conectada, puede ser debido al puerto USB. Por favor, pruebe con otro puerto y asegúrese de que esté activo.

La luz estará cargada en 4–8 horas (2.5–6 horas con carga de alta eficiencia), o cuando el botón esté iluminado de color verde o azul.

- Desconecte la luz del cargador y vuelva a colocar la cubierta de protección USB. Asegúrese de que la cubierta protectora USB está bien colocada para una resistencia al agua óptima.



Más Información

Para más información sobre productos Lezyne, visite nuestra página web: www.lezyne.com

Manuel de l'utilisateur en Français

LIRE ENTIEREMENT LE MANUEL AVANT UTILISATION pour assurer un usage et un entretien correct de votre lampe LED Lezyne. Les codes de la route concernant les lumières sont différents selon les pays. Informez-vous sur les règles du pays d'utilisation. Les lampes LED Lezyne ne sont pas homologuées par les règles "StVZO" du code de la route de l'Allemagne.

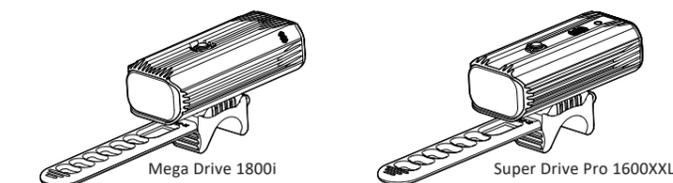

Recommandations

NE PAS REGARDER DIRECTEMENT LE FAISCEAU LUMINEUX ni l'orienter vers les yeux d'autres personnes.

Les éclairages LED Lezyne sont résistants à l'eau conformément à l'indice IPX7 relatif à la résistance à l'eau défini par la norme CEI 60529. Il n'est pas recommandé de mettre l'appareil sous l'eau. Si de l'humidité entre dans le boîtier, aérer celui-ci jusqu'à ce qu'il soit complètement sec.

NE PAS TENTER DE DEMONTER L'ELECTRONIQUE. Ceci annulerait la garantie.

Lezyne USA, Inc. ne pourra être tenue comme responsable des blessures ou dommages causés par l'utilisation de ce produit dans quelque circonstance que ce soit.

Garantie

Aux USA et au Royaume Uni, les lampes LED Lezyne sont garanties deux (2) ans à partir de la date d'achat (une preuve d'achat est nécessaire). Les batteries Lezyne sont garanties pendant six (6) mois à partir de la date d'achat. Les garanties Lezyne couvrent tous les défauts de fabrication ou de matériaux. La garantie ne couvre pas l'usure normale, une mauvaise installation, les tentatives d'accès ou de modification de l'électronique, les accidents, un mauvais usage, la maltraitance et/ou la négligence.

Pour toutes questions relatives à la garantie à l'extérieur des USA, contactez directement votre revendeur.

Pour toutes questions relatives à la garantie contactez : warranty@lezyne.com

Montage / 取付け

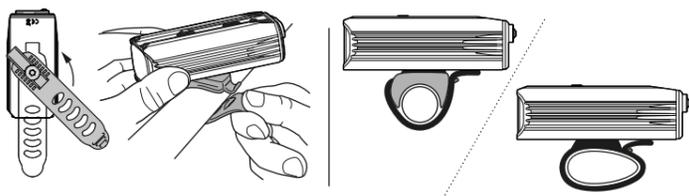

Fonctionnement

- Marche /Arrêt : enfoncer le bouton pendant deux (2) seconds.
- Changement de mode : appuyer sur le bouton.

MODE RACE : Lampe éteinte, maintenir le bouton enfoncé pendant cinq (5) secondes jusqu'à ce que la lampe clignote. La lampe est maintenant en Mode Race. Dans ce mode, seules les positions Overdrive et Economy sont sélectionnables. La lampe va rester dans ce mode même une fois éteinte. Pour repasser en Mode standard, répéter l’opération ci-dessus.

MODE MEMOIRE : Conserve en mémoire la dernière intensité de lumière utilisée.

PROTECTION THERMIQUE : si la température de fonctionnement devient trop élevée, la lampe va automatiquement baisser sa puissance.

Run Times and Modes

BLAST	ENDURO	ECONOMY	FEMTO	DAY FLASH	FLASH1	FLASH2	PULSE	OVERDRIVE
 1000 LUMENS	 600 LUMENS	 250 LUMENS	 15 LUMENS	 600 LUMENS	 150 LUMENS	 150 LUMENS	 150 LUMENS	 1800 LUMENS
 2:30 h :min	 3:45 h :min	 10:00 h :min	 148:00 h :min	 21:00 h :min	 33:00 h :min	 36:00 h :min	 38:00 h :min	 1:40 h :min

BLAST	ENDURO	ECONOMY	FEMTO	DAY FLASH	FLASH1	FLASH2	PULSE	OVERDRIVE
 1000 LUMENS	 600 LUMENS	 250 LUMENS	 15 LUMENS	 600 LUMENS	 150 LUMENS	 150 LUMENS	 150 LUMENS	 1600 LUMENS
 2:30 h :min	 3:45 h :min	 10:00 h :min	 148:00 h :min	 20:10 h :min	 33:00 h :min	 36:00 h :min	 38:00 h :min	 1:45 h :min

Packaging include

	MOUNTING STRAP	USB CABLE	KTV PRO SMART REAR	HANDLE BAR MOUNT	POWER PACK	REMOTE SWITCH
MEGA DRIVE 1800i	●	●				
MEGA DRIVE 1800i LOADED PRO	●	●	●	● (AL)	●	●
SUPER DRIVE 1600XXL	●	●				
SUPER DRIVE 1600XXL LOADED	●	●	●	● (CM)		

Power Pack Operation (Mega Drive 1800i loaded ONLY)



Remote Switch (Mega Drive 1800i loaded ONLY)

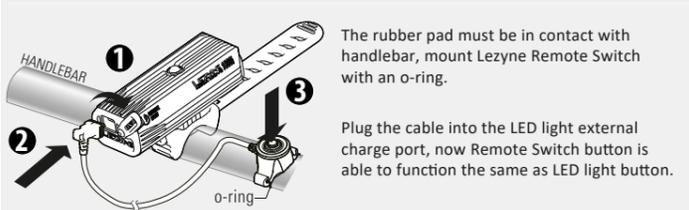

KTV PRO SMART REAR Instruction (Mega / Super loaded ONLY)

BATTERY				MOUNTING
	100-75%	75-25%	2-50%	
CHARGING				
	charging	charged	3hr USB charge	
RUN TIMES AND MODE				
 20 LUMENS	 3 LUMENS	 75 LUMENS	 25 LUMENS	 10 LUMENS
 4:00 h :min	 18:00 h :min	 10:00 h :min	 8:45 h :min	 19:30 h :min

Handlebar mount Instruction (Mega / Super loaded ONLY)

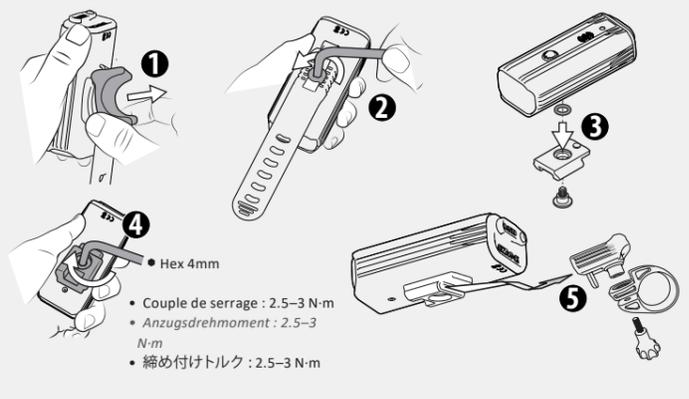

Indicateur de batterie

Les LED verte et rouge, dans le bouton indiquent l'état de la batterie quand la lampe fonctionne. Quand la lampe est à l'arrêt, cliquer une fois sur le bouton pour afficher le niveau de charge pendant deux (2) secondes.



Charge

Avant d'utiliser votre lampe LED Lezyne pour la première fois, chargez complètement la batterie. Pour charger la batterie de votre lampe :

- Eteindre la lampe
- Enlever le cache de protection USB
- Connecter le câble micro USB et la lampe à un port USB alimenté électriquement.
- Lors de la charge, le bouton clignote vert ; si le port USB le permet, la lampe va utiliser le mode de recharge à Haute Efficience (HE) et le bouton clignotera bleu.

Si le bouton ne clignote pas vert lorsque la prise est branchée, il se peut que le port USB ne soit pas alimenté électriquement : essayer un autre port USB.

La lampe sera recharge après 4–8 heures (2.5–6 heures avec la charge HE) ou dès que le bouton reste allumé vert ou bleu.

- Débrancher la lampe du chargeur et réinstaller le capot de protection USB—vérifier que le capot de protection est correctement installé pour assurer l'étanchéité.

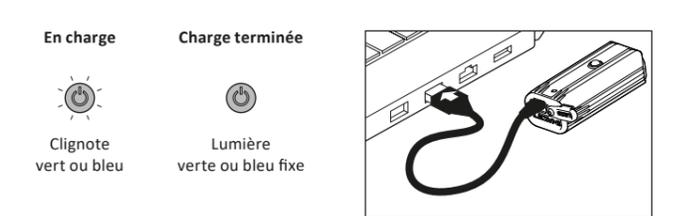

Plus d'information

Pour plus d'info sur les produits Lezyne, rendez-vous sur: www.lezyne.com

Deutsche Bedienungsanleitung

Bitte lesen sie vor der ersten Benutzung die gesamte Bedienungsanleitung durch, um eine sachgemäße Benutzung der Lezyne LED Lampe zu gewährleisten. Die Straßenverkehrsordnung unterscheidet sich von Land zu Land. Lezyne LED-Lampen sind in Deutschland nicht StVZO zugelassen. Wir empfehlen daher dringend, sich über vorherrschende Gesetze und Richtlinien zu informieren.

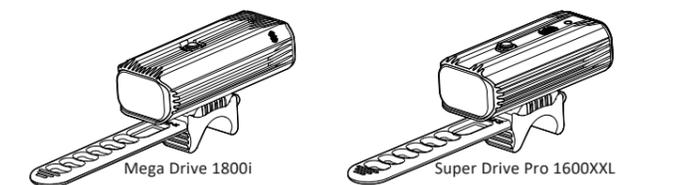

Warnung

Sehen Sie NIEMALS direkt in den Lichtstrahl der Lampe, oder richten diesen auf die Augen von anderen Personen. Lezyne LED Lampen sind wasserdicht nach IPX7 unter IEC Standard 60529. Dennoch ist ein Untertauchen nicht empfehlenswert. Sollte Feuchtigkeit eindringen, so lassen Sie das Gerat vollstaendig Lufttrocknen. Entfernen Sie NIEMALS die Elektronik. Dies hätte ein Erlischen der Garantie zur Folge. Lezyne USA, Inc. übernimmt in keinem Fall die Haftung für Verletzungen oder sonstige Schäden, die aus der Verwendung dieses Produkts resultieren.

Garantie

In den USA und im Vereinigten Königreich bieten Lezyne LED Lampen zwei (2) Jahre Garantie ab dem ursprünglichen Kaufdatum und für den ursprünglichen Eigentümer (Kaufnachweis erforderlich). Lezyne Akkus bieten sechs (6) Monate Garantie zu gleichen Voraussetzungen. Diese Garantie deckt Material-und Herstellungsfehler ab. Fälle, welche nicht von der Garantie abgedeckt sind: normaler Verschleiß, unsachgemäße Installation, der Versuch, auf die Elektronik zuzugreifen, Modifizieren der Elektronik, Beschädigung oder Ausfall durch Unfall, Missbrauch, falsche Behandlung und Vernachlässigung. Im Schadensfall (weltweit geltend), wenden Sie sich bitte direkt an den Händler, wo Sie das Produkte gekauft haben.

Bei Fragen bezüglich der Garantie wenden Sie sich bitte an warranty@lezyne.com

Benutzung

- AN/AUS: Den Knopf für 2 Sek. gedrückt halten.
- Moduswechsel: Knopf klicken.

RACE MODUS: Wenn das Licht ausgeschaltet ist, drücken und halten Sie den Knopf für fünf (5) Sekunden, bis das Licht blinkt. Ihre Lampe befindet sich nun im Race Modus, in welchem nur der Overdrive und der Economy Modus wählbar sind. Die Lampe wird in diesem Modus bleiben, selbst wenn Sie diese abschalten. Um in den normalen Modus zu wechseln, wiederholen Sie bitte den obigen Vorgang.

MODE MEMORY: Die Lampe behalt den gewählten Modus bei, wenn diese ausgeschaltet wird.

THERMISCHE SCHUTZSCHALTUNG: Sollte die Betriebstemperatur der Lampe zu hoch sein, so wechselt diese automatisch in den schwächsten Modus.

Laufzeiten und Modi

BLAST	ENDURO	ECONOMY	FEMTO	DAY FLASH	FLASH1	FLASH2	PULSE	OVERDRIVE
 1000 LUMENS	 600 LUMENS	 250 LUMENS	 15 LUMENS	 600 LUMENS	 150 LUMENS	 150 LUMENS	 150 LUMENS	 1800 LUMENS
 2:30 h :min	 3:45 h :min	 10:00 h :min	 148:00 h :min	 21:00 h :min	 33:00 h :min	 36:00 h :min	 38:00 h :min	 1:40 h :min

BLAST	ENDURO	ECONOMY	FEMTO	DAY FLASH	FLASH1	FLASH2	PULSE	OVERDRIVE
 1000 LUMENS	 600 LUMENS	 250 LUMENS	 15 LUMENS	 600 LUMENS	 150 LUMENS	 150 LUMENS	 150 LUMENS	 1600 LUMENS
 2:30 h :min	 3:45 h :min	 10:00 h :min	 148:00 h :min	 20:10 h :min	 33:00 h :min	 36:00 h :min	 38:00 h :min	 1:45 h :min

Batterie Indikator

Eine im Knopf befindliche LED zeigt ständig den aktuellen Ladezustand des Akkus an, wenn die Lampe eingeschaltet ist. Im abgeschalteten Zustand genügt ein Klicken des Knopfes, um den Ladezustand für eine Sekunde anzuzeigen.



Laden

Bevor Sie ihre Lezyne Lampe zum ersten Mal benutzen, sollte Sie diese voll laden. Dazu bitte folgendes beachten:

- Schalten Sie das Licht aus
- Entfernen Sie die USB Schutzkappe
- Verbinden sie das Micro USB Kabel und die Lampe mit einem stromführenden USB Steckplatz.
- Wenn die Lampe läd, blinkt diese grün. Sollte der USB Steckplatz genügend Strom führen, so wird die Lampe zum HE Laden wechseln und dieses durch eine blau leuchtende LED anzeigen.

Sollte der Knopf nicht blinken, nachdem die Lampe eingesteckt wurde, so wechseln Sie bitte den USB Steckplatz. Die Lampe ist nach 4–8 Stunden (2.5–6 mit HE Laden) voll geladen, oder wenn die LED konstant grün oder blau leuchtet.

- Entfernen sie die Lampe vom Ladekabel und schließen sie die USB Schutzkappe, um das Eindringen von Wasser zu verhindern.

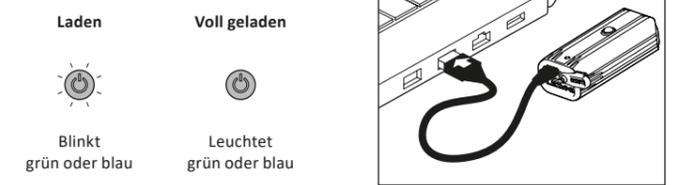

Mehr Informationen

Für mehr Informationen über Lezyne Produkte, besuchen Sie bitte: www.lezyne.com

ユーザーズマニュアル

新しいLezyne LED ライトの適切な使用方法と注意事項を確認するために、使用前にこの説明書をすべて読んでください。照明を義務付ける交通規則は国ごとに決められています。使用する国での照明に関する法規を確認してください。Lezyne LEDライトは、ドイツの道路交通許可規則“StVZO規格”に適合していません。

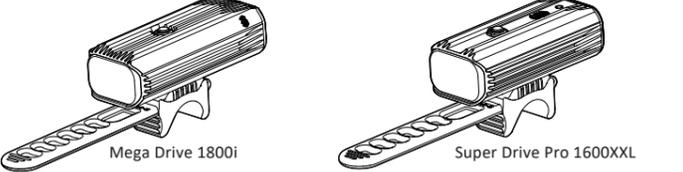

警告

光線を直視したり、他人の目に当てたりしないでください。Lezyne LEDライトはIEC規格60529に基づくIPX7等級の耐水性能を持っています。製品を水に浸すことは推奨しません。万が一、水がボディに入った場合、完全に乾燥するまで外気にさらしてください。電子機器を取外そうとしないこと。そうした場合保証対象外となります。アメリカLezyne USA 社いかなる状況でもこの製品に起因するけがやその他の損害については、一切の責任を負いません。

保証

アメリカイギリスではLezyne LEDライト本体は正常な使用状態で故障した場合ご購入日から2年間保証いたします。(ご購入を証明できる書類が必要です) Lezyne製バッテリーの製造工程で不具合については、ご購入日から6ヶ月間保証いたします。保証はライトの本体の材質、製造工程での不具合や問題が発生した場合、無償修理、交換いたします。通常の使用による消耗、不適切な取付け、内部電子部品への接触や改造・事故・転倒などによる傷や故障、取扱説明書に記載の使用方法以外での用途・方法で使用された場合、または分解された場合は、保証の対象外となる場合がございます。

各国の保証については、製品を販売した小売店にご相談ください。保証に関する質問は下記までお問い合わせください。 warranty@lezyne.com

操作方法

- On/Off : ボタンを2秒間長押し
- モード変更 : ボタンを短く押す

レースモード : ライトをオフにした状態で点灯するまで5秒間ボタンを長押しします。レースモードは最高照度のオーバードライブモードとエコノミーモードの2種類だけの選択になります。このまま電源をOFFにしてもレースモードが継続します。ノーマルモードに戻る場合は上記の手順を繰り返します。

モードメモリー : ライトを消したときに設定されていたモードが記憶されます。熱からの保護 : ライトの温度が高すぎると、自動的に低出力設定に切り替わります。

持続時間とモード

BLAST	ENDURO	ECONOMY	FEMTO	DAY FLASH	FLASH1	FLASH2	PULSE	OVERDRIVE
 1000 LUMENS	 600 LUMENS	 250 LUMENS	 15 LUMENS	 600 LUMENS	 150 LUMENS	 150 LUMENS	 150 LUMENS	 1800 LUMENS
 2:30 h :min	 3:45 h :min	 10:00 h :min	 148:00 h :min	 21:00 h :min	 33:00 h :min	 36:00 h :min	 38:00 h :min	 1:40 h :min

BLAST	ENDURO	ECONOMY	FEMTO	DAY FLASH	FLASH1	FLASH2	PULSE	OVERDRIVE
 1000 LUMENS	 600 LUMENS	 250 LUMENS	 15 LUMENS	 600 LUMENS	 150 LUMENS	 150 LUMENS	 150 LUMENS	 1600 LUMENS
 2:30 h :min	 3:45 h :min	 10:00 h :min	 148:00 h :min	 20:10 h :min	 33:00 h :min	 36:00 h :min	 38:00 h :min	 1:45 h :min

バッテリーインジケータ

ライトがオンのときにバッテリーの状態がわかるよう、緑と赤のLEDがボタン内にあります。ライトがオフのときはボタンを1回押すと、2秒間バッテリー状態を表示します。



充電方法

最初にLezyne LEDライトを使用する前に、バッテリーをフルに充電してください。充電方法は以下の通りです。

- ライトをオフにする
- USB端子の保護カバーを開けてください。
- 通電したマイクロUSBケーブルを接続します。
- 充電がはじまると、電源ボタンが緑色に点滅します。HE急速充電に対応したケーブルを使用すると青色に点滅します。

もし充電を開始してもボタンが点滅しない場合は、USBポートの容量が不足している場合があります。他のポートに差し替えてください。4-8時間でボタンが緑色の点灯に変われば充電完了です。(HE充電の場合は2.5-6時間で青色に点灯します)

- USBケーブルを取り外し、USBポートの保護カバーを防水のためしっかり装着して下さい。



詳細情報

Lezyne製品についての情報はサイトで: www.lezyne.com